

Smart materials

Fiber Optics / Invisibility

Liquid Crystals

Shape memory alloys

Ferrofluid

Amorphous Metal

Thermoelectric

Piezoelectric

Light travels in a straight line.
Can you make light go around a corner?

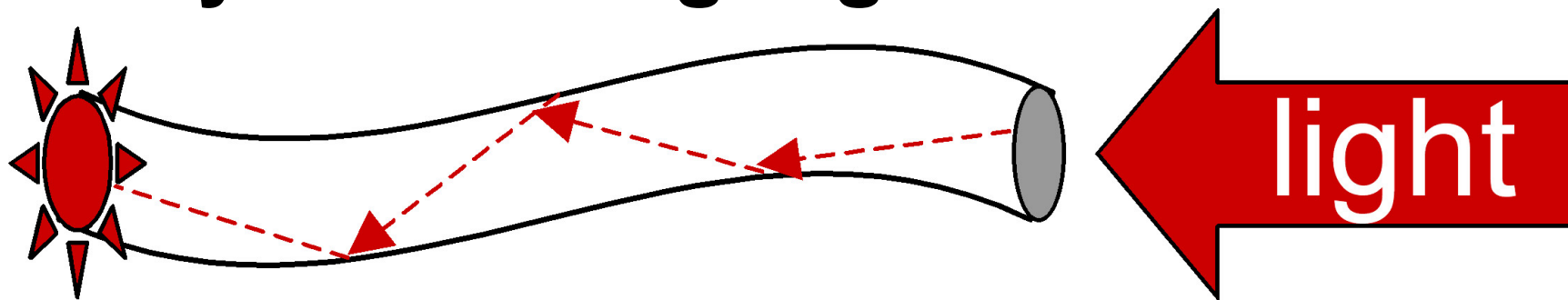

Try holding the LED flashlight at one end of a **fiber optic**, then gently **bend** the fiber and watch the light glow at the other end.

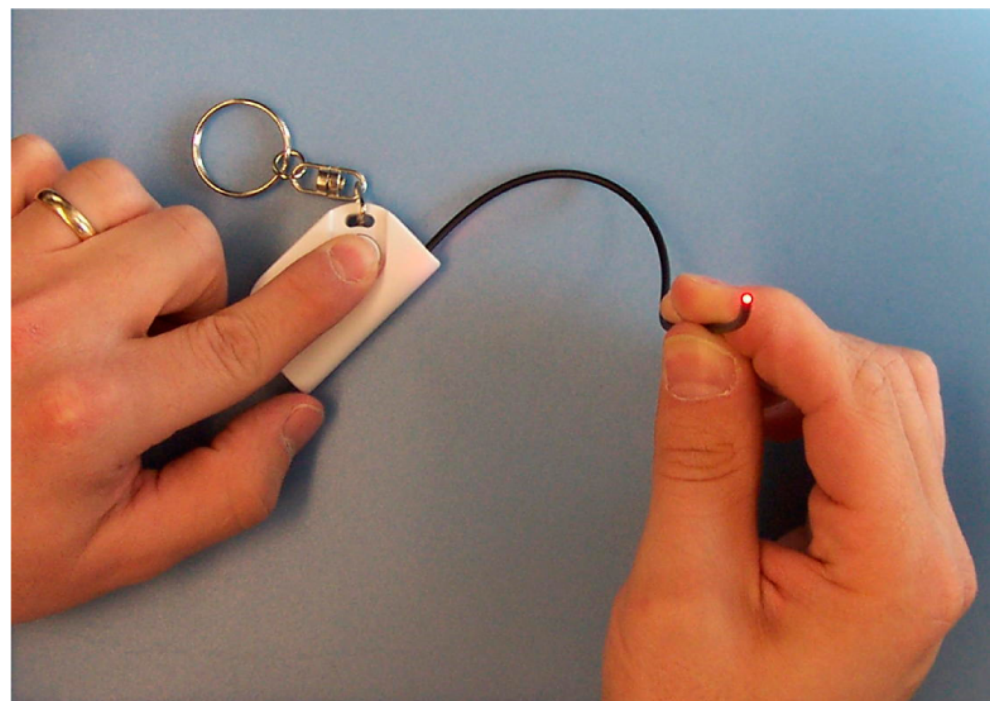



Take a piece of **memory metal wire** and bend it.

Drop the wire into very hot water.

What happens?
Can you do it twice?

cold

hot

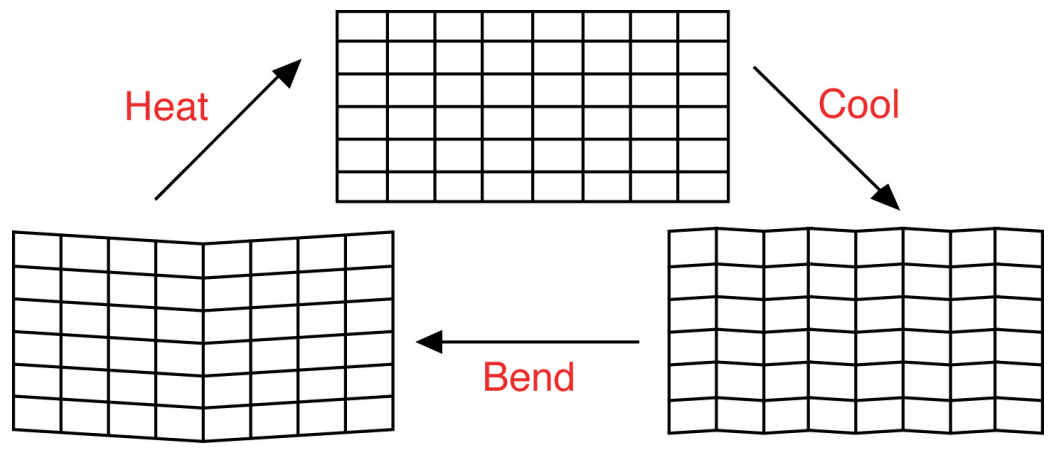
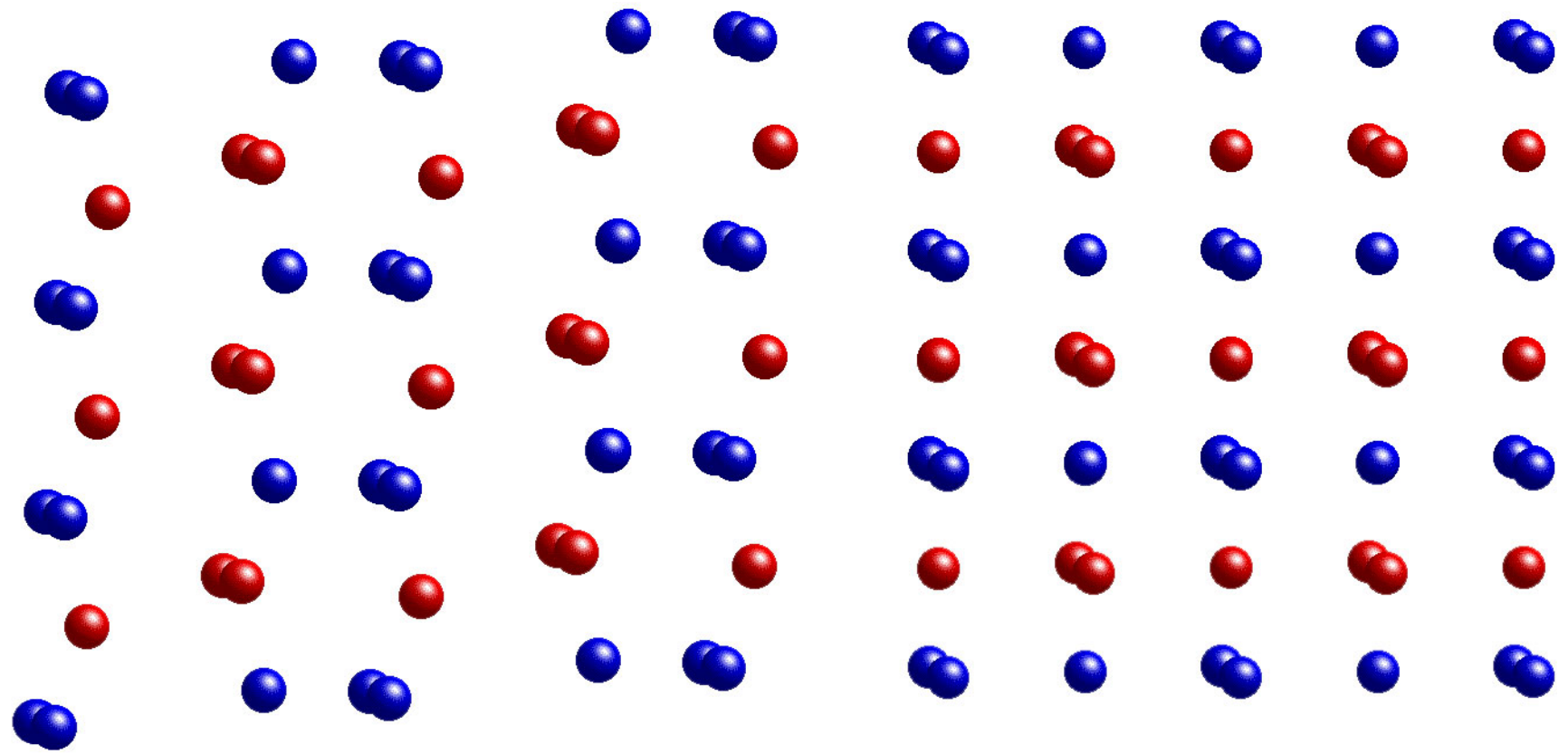

Listen when you drop
each **memory metal rod**.



The more symmetric structure will ring.

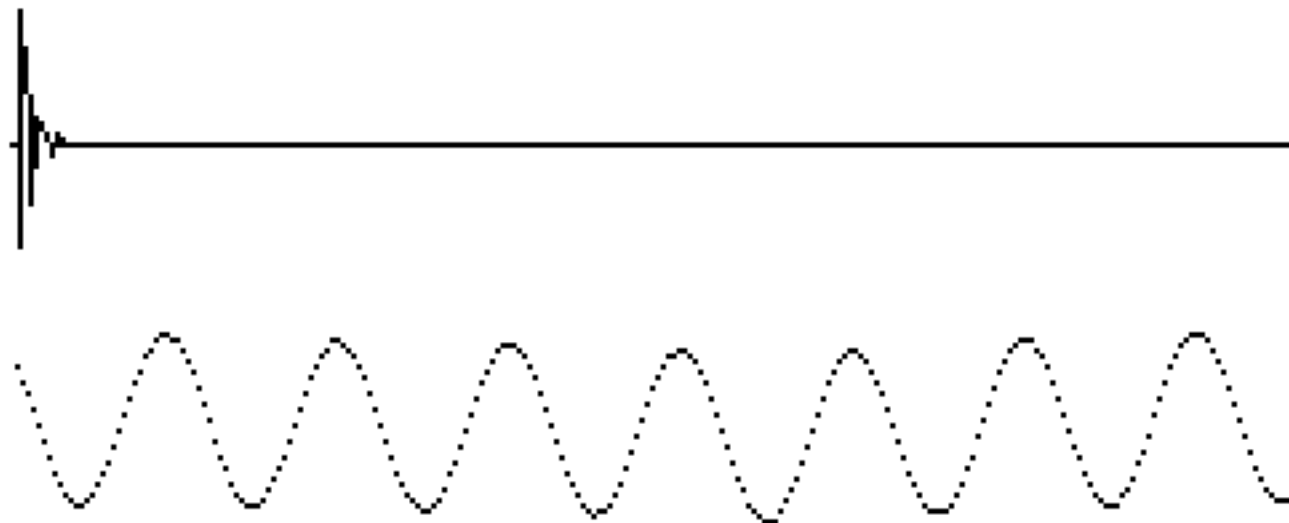

Which rod is the high temperature form?
Which rod is the low temperature form?
Can you **change** the ringing property?

What can you make with memory metal?

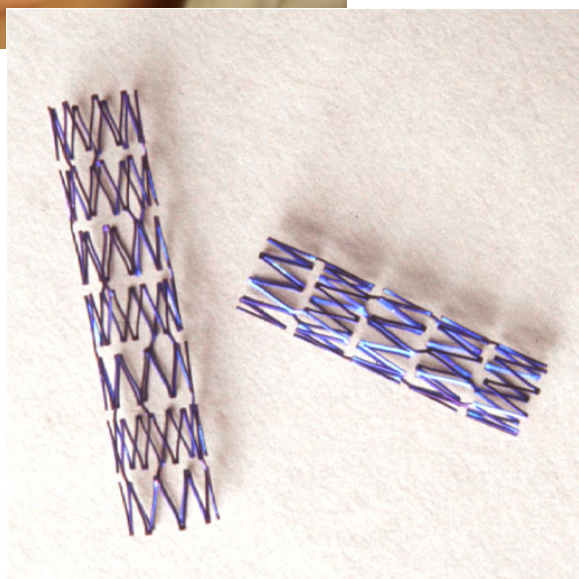

Shower Gard anti-scald safety device

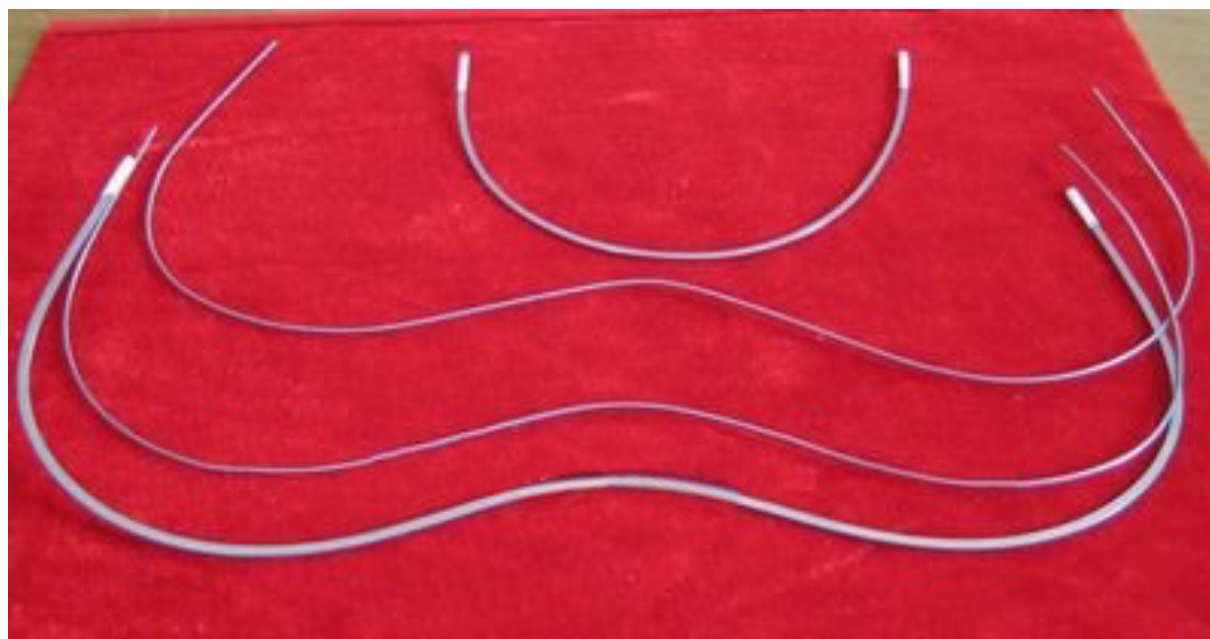
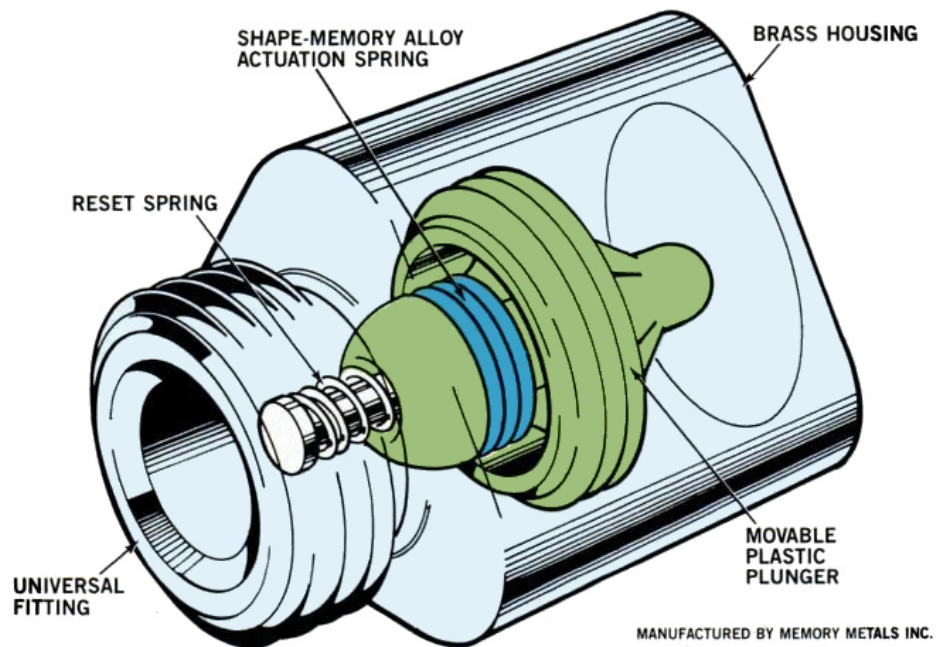

If you melt a **liquid crystal display**

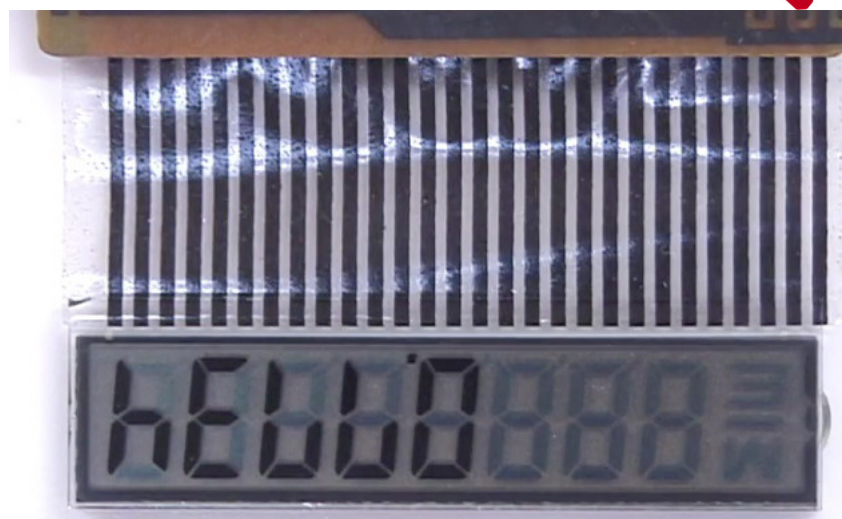
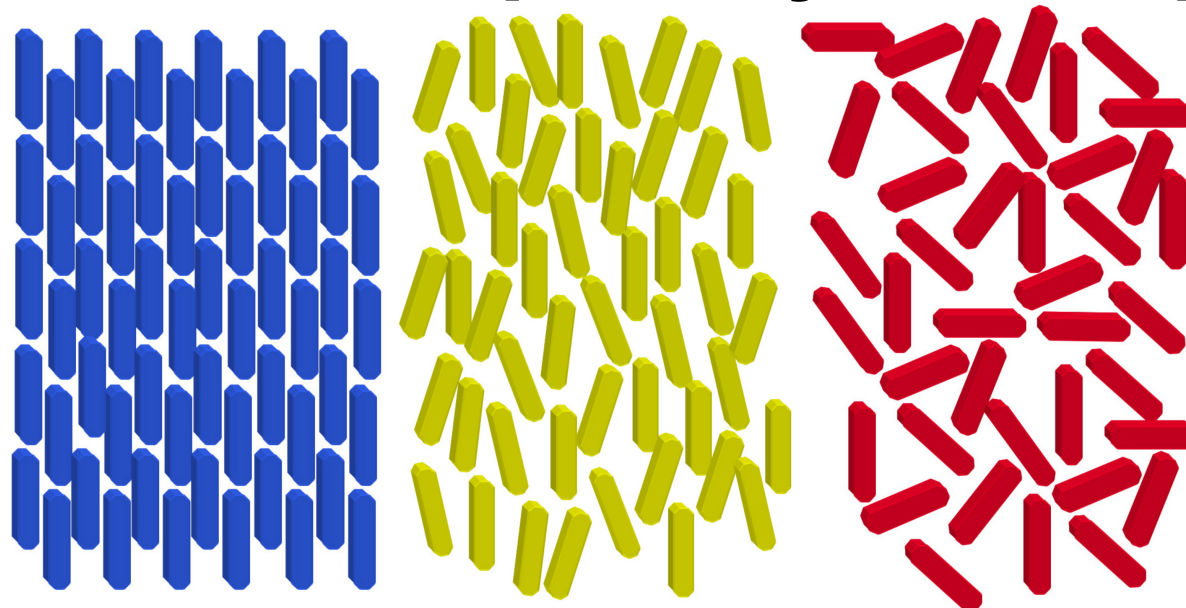

does it work again when it cools off?

Can you darken a **liquid crystal** window using electricity? **Flip the switch.**

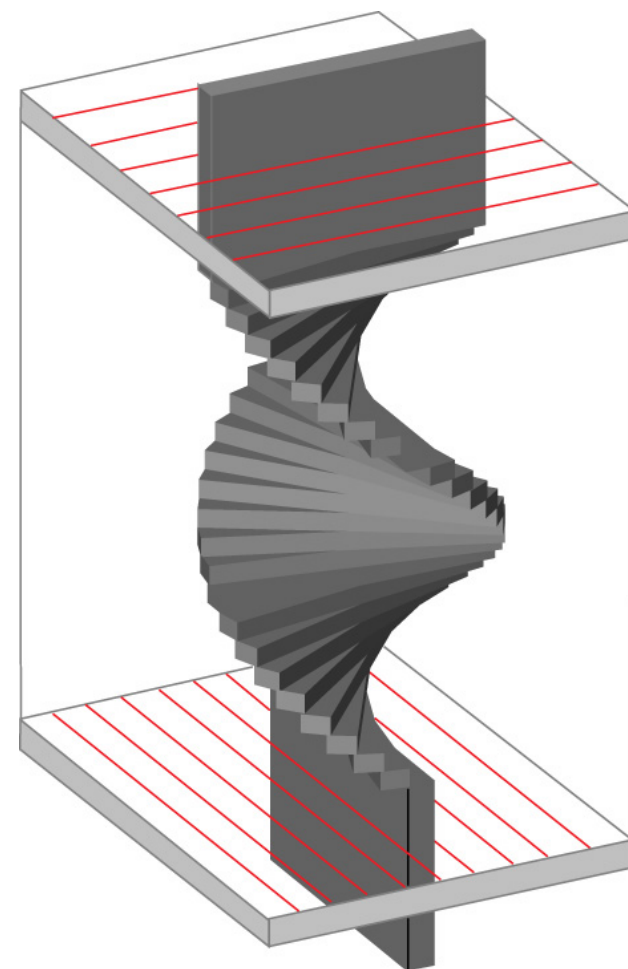
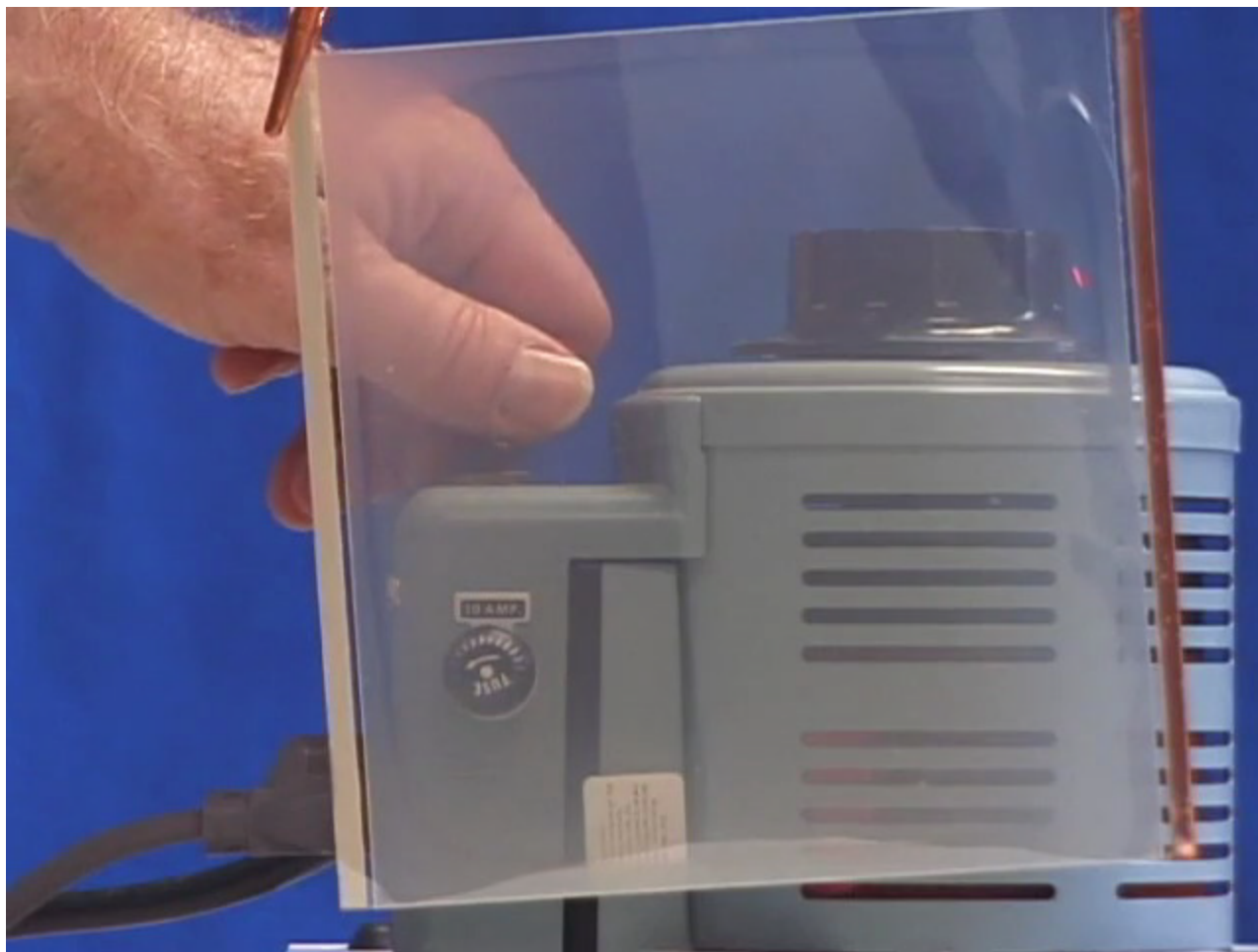

Is it reversible? What is this good for?

1. **Hold** your hand somewhere on the tabletop.

Use a **liquid crystal sheet** to see where your hand was.

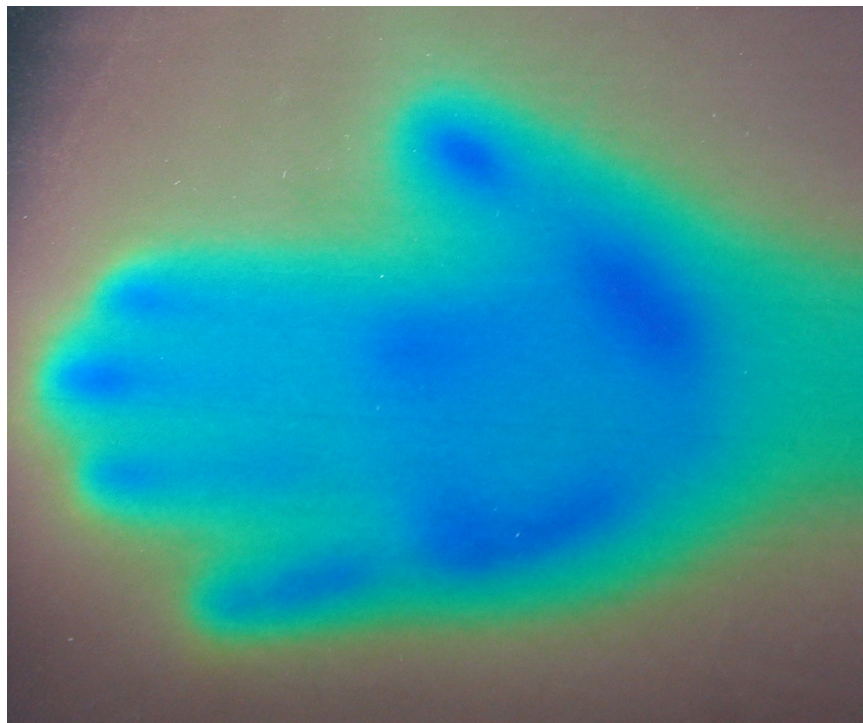

2. What objects have we hidden in the envelopes? (How can you tell without opening the envelope?)

Magnetite particles are solid but if you make them small you can suspend them in a liquid.

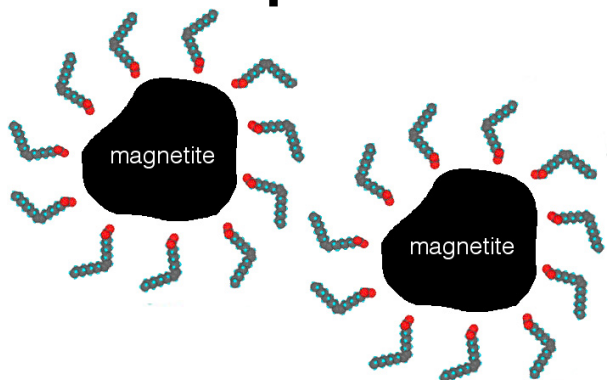

Do they still respond to a magnet?
Can you attract a liquid to a magnet?



Adjust the power to the electromagnet to make the ferrofluid go up and down.

Where is the magnetic field strongest?



What do you see
in the container of
baby oil?

Lift the stick.
Do you see the
same thing?



What would you do with an invisibility
cloak?

This material has a barrier that only lets high energy electrons pass through.

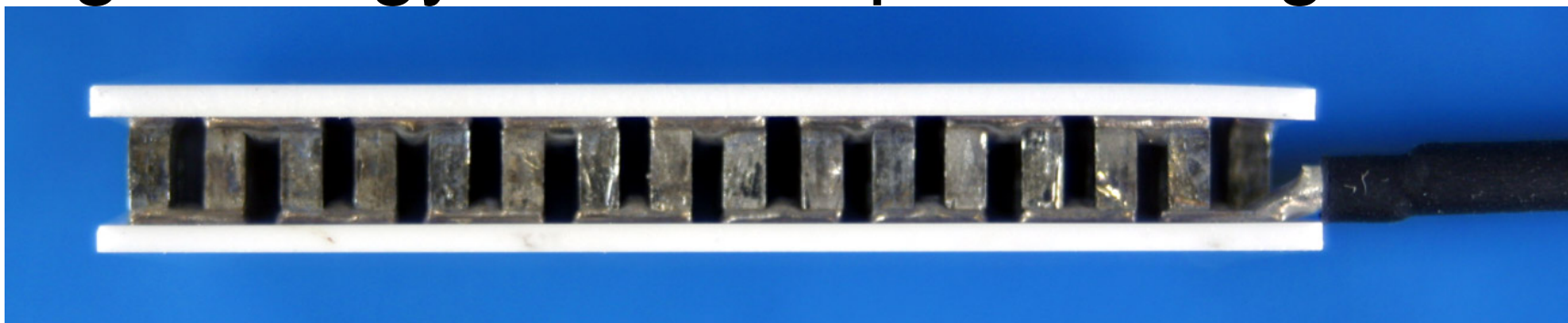

Use your thumb and finger to **touch both sides (the white parts.)**

Have **someone else turn the crank** to make the electrons move.

What do you notice if the high energy electrons move from one side of the material to the other?

Bounce the same steel ball on two different metals. Which bounces more?

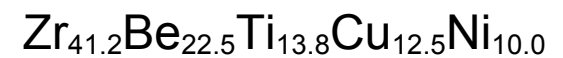
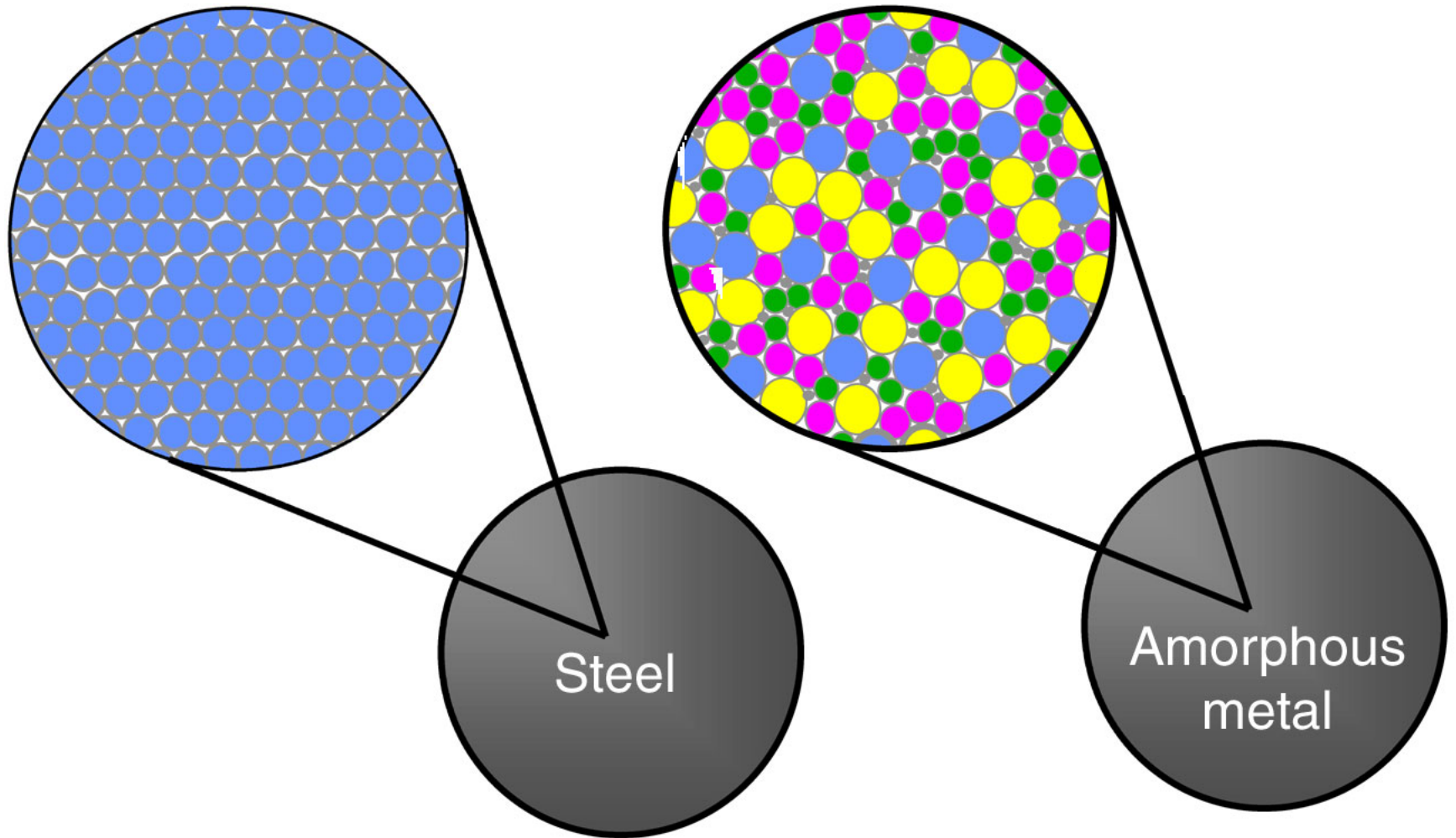

Do things bounce better when hard or soft? **Bounce** two kinds of rubber balls.

Rawlings
R



LiquidMetal® alloy is different from conventional materials because of its liquid (or "amorphous") atomic structure. This means that LiquidMetal® alloy does not deform on impact, resulting in 29% more energy return.

Tap on the disk with a pencil eraser.
Do you make enough electricity to **light** the LEDs? What color light do you see?

There is a piezoelectric ceramic disk between two metal plates. Moving the ions in the disk moves charges and creates electricity. When the ions relax back, electricity flows the other direction. One LED lights during the forward current and the other LED lights during the backward current.

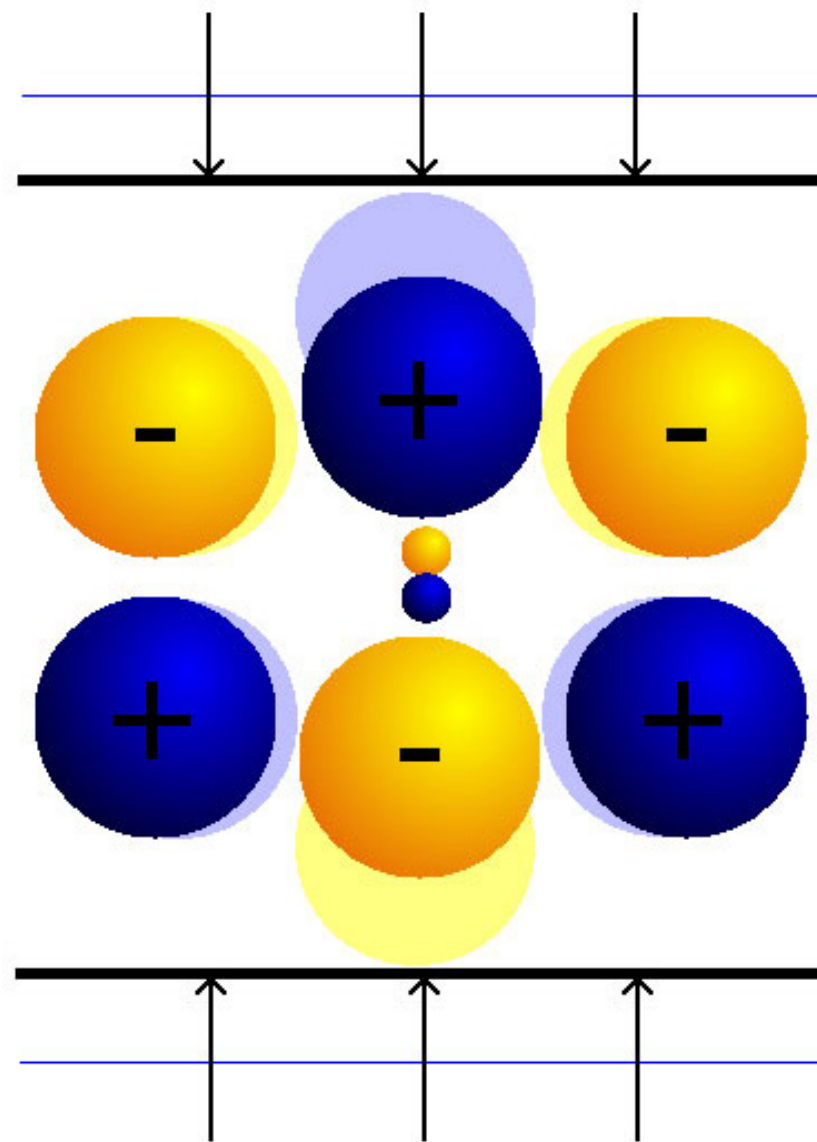

Squeeze the barbecue lighter. Do you make a spark? What else could you light with this spark?

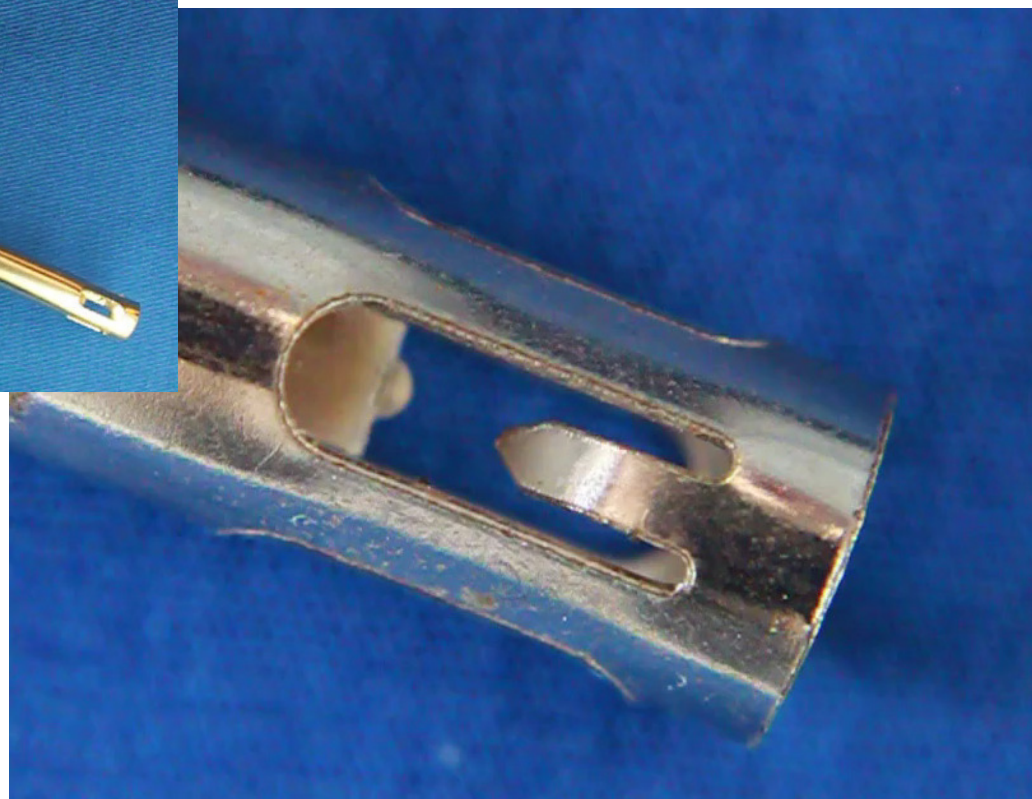
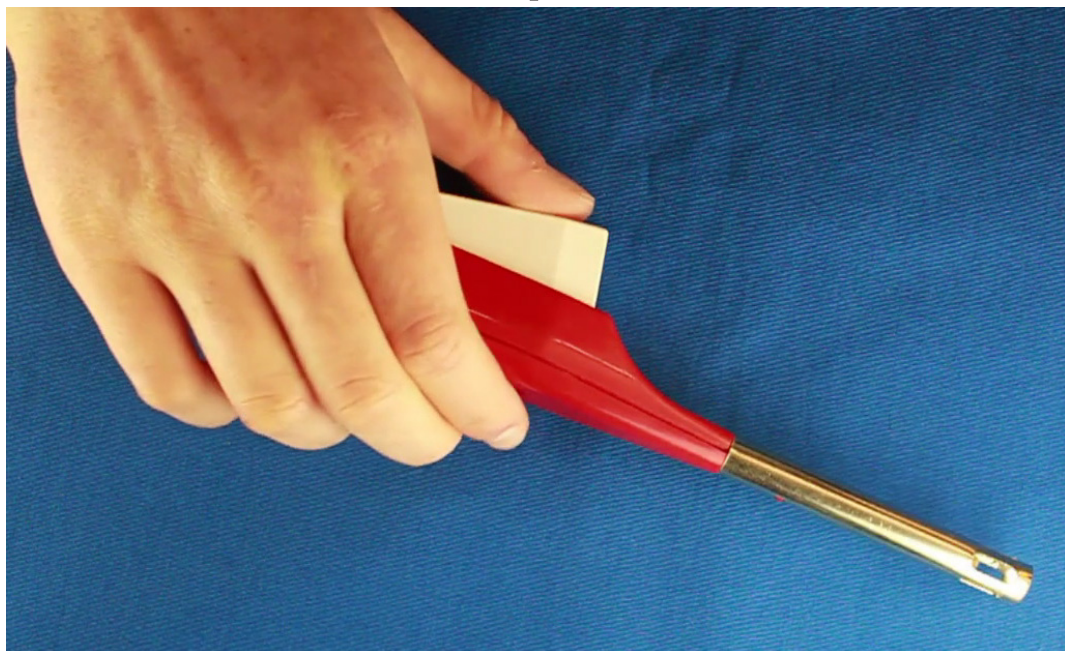

Squeeze some water onto the blue sand. **Tip** the container. What happens?



Sprinkle the blue sand onto a cup of water. What happens? **Scoop** the sand back out with a spoon. Is the sand wet?

The colored sand has been chemically treated to repel water. You cannot see the thin coating but it changes the properties.